

CALIPRI

C4X

CAPTURES
COMPLEX
CONTOURS



PROFILE MEASUREMENT IN
RAILWAY INFRASTRUCTURE

NEXTSENSE

WHY CALIPRI?

- ✓ Highly accurate profile measurement gauge
- ✓ Non-contact laser technology → No inaccurate mounting
- ✓ Patented roll and pitch correction → User-independent results
- ✓ Digital measurement data → No read-off errors or handwritten data transfer Multifunctional device and individual configuration:
 - rail
 - switch
 - defects
 - track geometry
 - equivalent conicity
 - profile compare



- ✓ Results as color-coded values and profile on sensor & tablet PC
- ✓ Unique calibration standard for self-test and autonomous recalibration
- ✓ Approved according to national and international standards
- ✓ International market presence with > 2000 devices in use
- ✓ Technical support and more than 40 sales partners worldwide

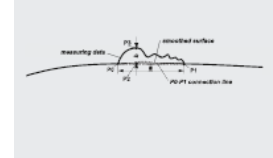
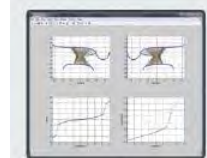
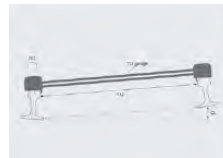
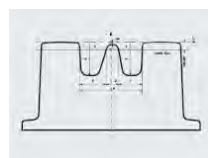
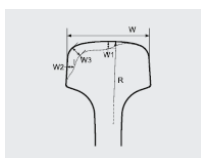
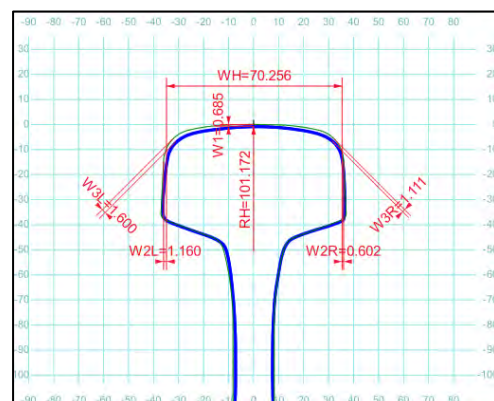

SCOPE OF SUPPLY & SERVICE



- ✓ Sensor
- ✓ Tablet PC
- ✓ Calipri Software Suite
- ✓ Calibration standard
- ✓ Carrying strap & belt clip
- ✓ Hard-shell case
- ✓ Instruction manual
- + Measurement modules / features of your choice



Calibration standard

Our reference standard allows you to recalibrate the measuring device on site if required. This means that you benefit from a measuring system with high availability.



Calipri Software Suite

Define your measurement plan and tolerance classes in Calipri manager. Use Calipri Portable Operator to execute the measurements and analyze the condition of your wheelsets (results displayed as numerical values, 2D profile and traffic light system). Print results as PDF reports or export to your database.

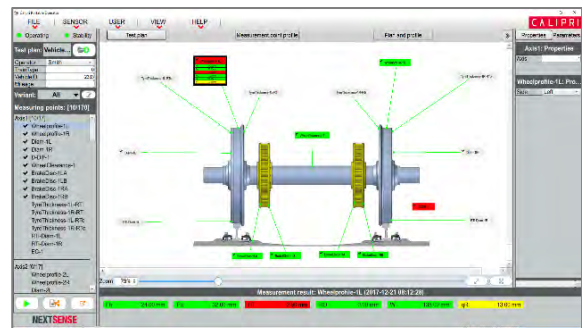

RAIL

APPLICATION

- Measuring complete vignole and grooved rails
- Comparison with individual reference values
- Check wear parameters in predictive maintenance
- Quality control checks in rail manufacturing

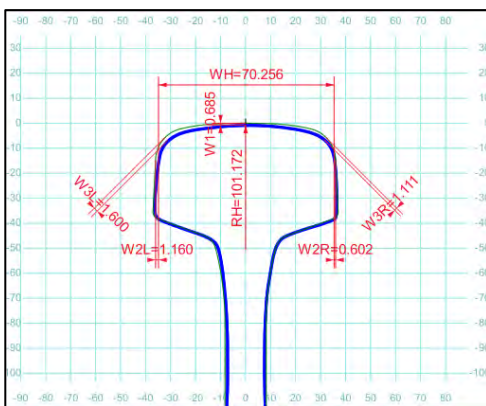

VIGNOLE RAIL

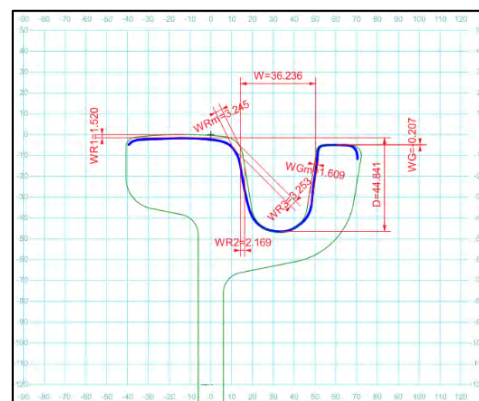

GROOVED RAIL



SCOPE OF SUPPLY & SERVICE:

- ✓ Software license measurement module rail
(Activation through remote access possible also at a later date)

TECHNICAL DATA

Accuracy	Absolute accuracy < $\pm 80\mu\text{m}$ Repeatability < $\pm 35\mu\text{m}$
Reference profile	Many rail types are already integrated (detailed list available upon request)
Measurement methods	RailProfile, GroovedRailProfile RailComplete
Product ID	CMM3001

SWITCH

APPLICATION

- Measurement of switch frogs and switch blades
- Determination of the lowering of the point of crossing
- Comparison with predefined limit values
- Lightweight gauge (carbon fiber)



SWITCH BLADE

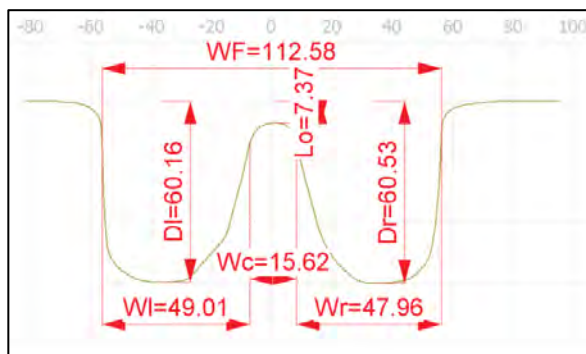

SWITCH FROG

SCOPE OF SUPPLY & SERVICE

- ✓ Software license for Measurement Module "Switch"
 - Activation through remote access
 - 2 measurement methods (Switch blade, Switch frog)
- ✓ Linear guidance
 - Carbon fiber supporting gauge in hard shell case
 - Replaceable fixture for C42 sensor

TECHNICAL DATA

Package size	100 x 20 x 45 mm 4 x 0.8 x 1.8 in
Weight (Linear guidance)	3 kg 6.6 lb
Guided path (Slide)	550 mm 21.6 in
Product IDs	CMM3003/C42



DEFECTS

APPLICATION

- classification of defects on railway wheels, rails and switches
- wheel flats, cracks and spalling are detected
- depth and the width of the defect is calculated and displayed



MEASUREMENT METHOD „SLIDFLAT“

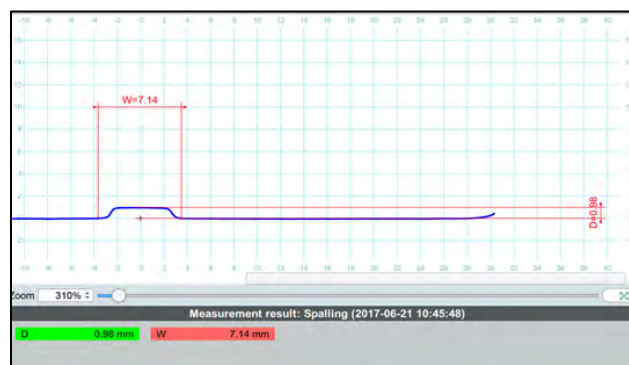

MEASUREMENT METHOD „SPALLING“



SCOPE OF SUPPLY & SERVICE:

- ✓ Software license measurement method “Defects”
 - 2 measurement methods (SlidFlat, Spalling)
 - In case of system extension (supplementary order): activation via remote access

TECHNICAL DATA

Measurement range (WxD):	Wheel flat: 15,0 x 0,1 to 80,0 x 2,0 mm (0.6'' x 0.004'' to 3.1'' x 0.08'') Cracks and spalling: 1,0 x 0,5 to 50,0 x 5,0 mm (0.04'' x 0.02'' to 2.0'' x 0.2'')
Application range	For all common heavy and light rail wheels, rails and switches
Dimensions	Width Depth
Product ID	CMM1007

TRACK GEOMETRY

APPLICATION

- Measurement of track gage, cross level & rail cant
- Light weight gauge
- Single gauge positioning
- Direct calculation of twist

ADD-ONS

GPS/LTE Expansion

- For recording GPS data
- Product ID: CAO3029

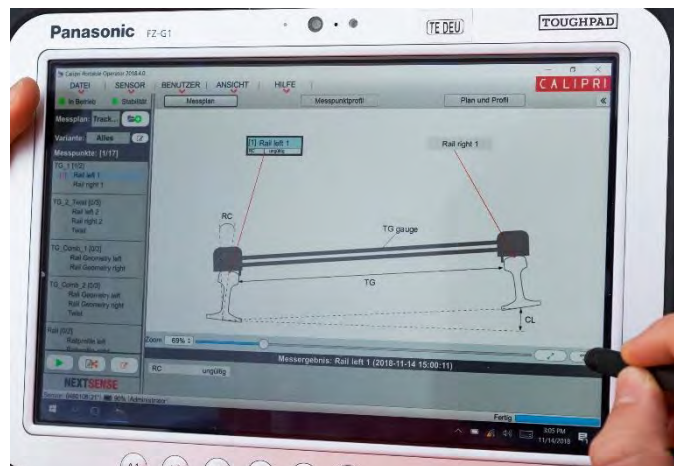

SCOPE OF SUPPLY & SERVICE:

- ✓ Track geometry gage TG1435 (for regular track)
 - Mechanical gage for track geometry measurement
 - 14 mm (0.04 in) pin length (other pin length available upon request)
 - Delivery in hard shell case for shipping and storage
- ✓ Software license measurement module "Track Geometry"
 - 1 measurement method (RailGeometry)
 - By system expansion (in case of supplementary module purchase): activation via remote access

TECHNICAL DATA

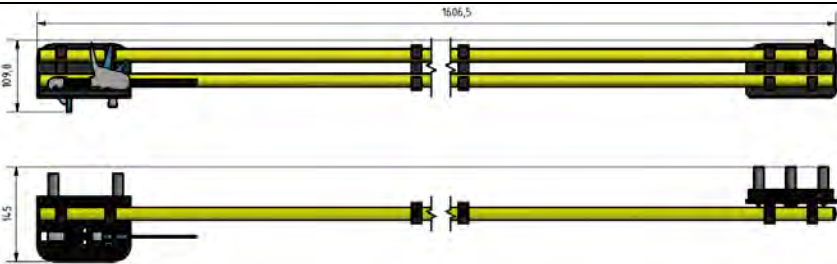
Nominal track width	1435 mm 56.50 in ¹ (Measurement range 1420-1485mm 55.90-58.46 in)		
Maximal deflection	12°		
Net weight	3.3 kg 1165.04 oz		
Dimensions	 <p>63.3 x 4.3 x 5.7in case 68.9 x 9.8 x 9.8 in</p>		
Accuracy (requirements according to DIN 13848-4:2012)		Absolute	Repeatability
	Track gauge	+/- 0.2mm	+/- 0.1mm
	Cross level ≤ 50mm	+/- 1.5mm	+/- 0.5mm
	Cross level > 50mm	+/- 2.0mm	+/- 0.5mm
Compatibility	CALIPRI C42 as of release 2018.4.0		
Product ID	CMM3004		

¹ Other gage widths available upon request.

EQUIVALENT CONICITY (EC)

APPLICATION

- Precise analysis of the wheel rail interface
- Determining of possible vibrations and irregularities in vehicle dynamics and critical speed of railway vehicles
- The conicity value (EC), calculated according to UIC 519 norm and EN 15302 norm

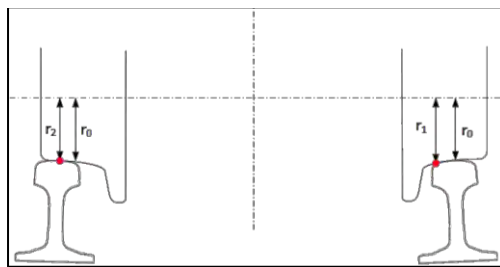

ROLLING RADIUS DIFFERENCE
due to lateral displacement of the wheelset

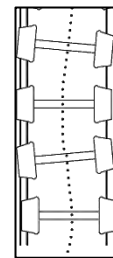

SINUSOIDAL MOTION
typical motion pattern

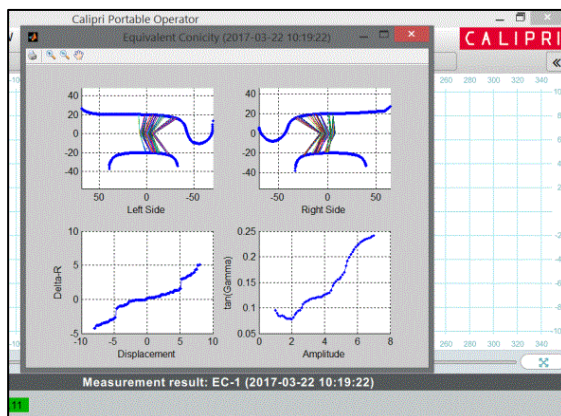

SCOPE OF SUPPLY & SERVICE:

- ✓ Software license measurement module “Equivalent Conicity”
 - 1 measurement method
 - In case of system extension (supplementary order): activation via remote access

TECHNICAL DATA

Accuracy	Complies with UIC 519 and EN 15302
Field of application	For all common heavy and light rail wheel and rail profiles
System requirement	Licensed measurement module „Wheel profil“ or „Rail“
Necessary Input Data	-) Wheel profile (measured or chosen from standard profiles) -) Wheel diameter and wheel back-to-back distance (measured or manual input) -) Rail profile (measured or chosen from standard profiles) -) Track gauge and rail inclination (manual input or measured)
Product ID	CMM1011

PROFILE COMPARE

APPLICATION

- Analyze wear evolution by comparing with previous measurements
- Wear analysis of worn rails against standard models (csv/dxf)
- Compare wear of e.g. left and right rail
- Check correct grinding/reprofiling of rails against standard model
- Profile comparison with mouseover and elevated pins

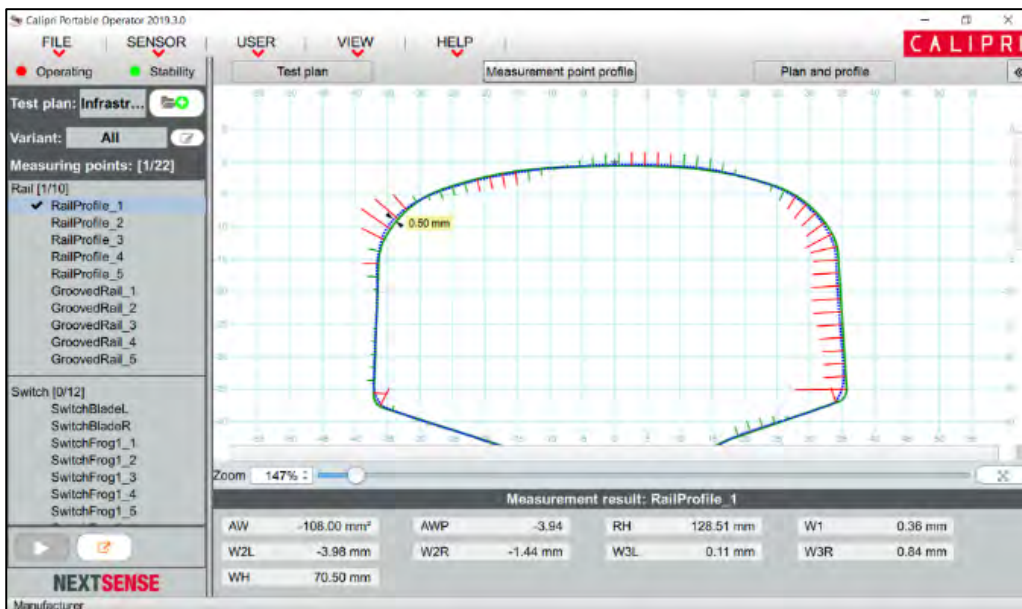

RAIL PROFILE COMPARISON

SCOPE OF SUPPLY & SERVICE:

- ✓ Software license "ProfileCompare"

TECHNICAL DATA

System requirement	Calipri software version 2019.3 or higher
Reference profiles	CSV or DXF files Profile of other measurement point Stored template profile in measurement plan
Product ID	CMF9120/RAW RAIL PROFILE COMPARISON

REFERENCES

