

# DEEN U

## descriptif technique





---

## **Informations générales :**

### **Garantie :**

Produits .mdd - **5 ans**

Composants électriques et tissus - **2 ans.**

### **Méla miné - certifié :**



### **Montage :**

livrée en pièces détachées

### **Emballage :**

carton, enveloppe en plastique perforé

### **Conforme aux normes :**

PN-EN 527-2:2017-02

### **Densité du panneau :**

12 mm - 690 - 750 kg/m<sup>3</sup>

18 mm - 650 - 690 kg/m<sup>3</sup>

28 mm - 610 - 630 kg/m<sup>3</sup>

36 mm - 610 - 630 kg/m<sup>3</sup>

## Plateaux bureaux Ogi

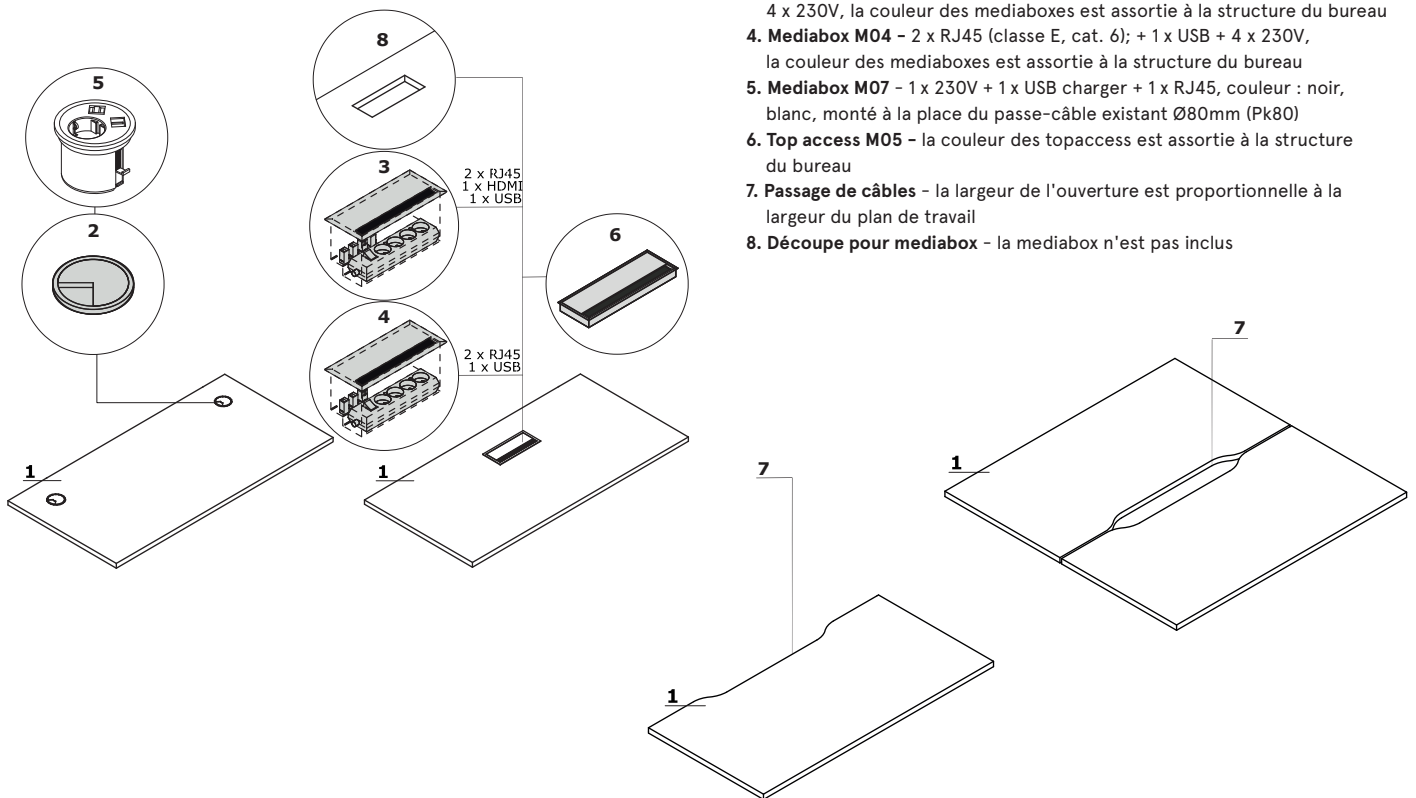

## Dimensions des surfaces de travail (mm)

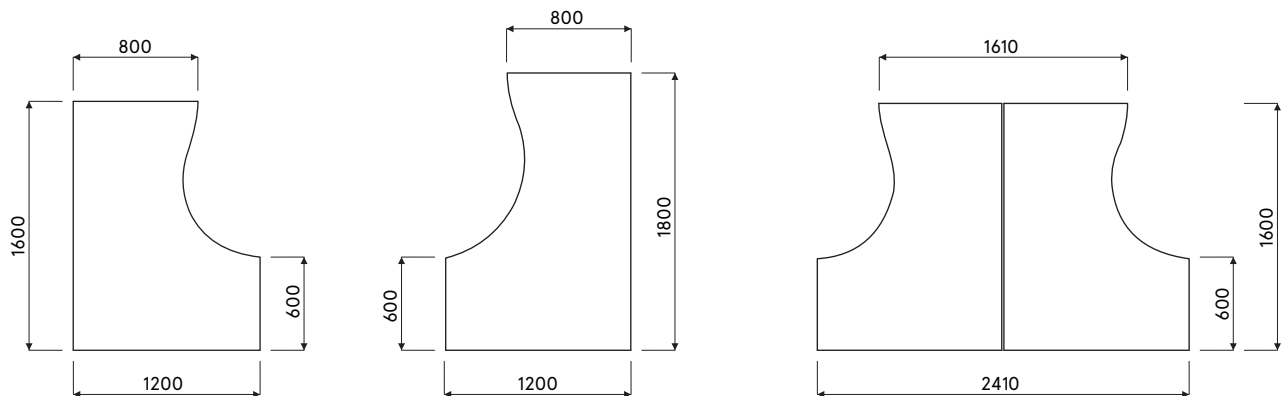

## Piétement

Ogi U : métal finition peinture poudre époxy, profil 60x30 mm, entretoise 10 mm

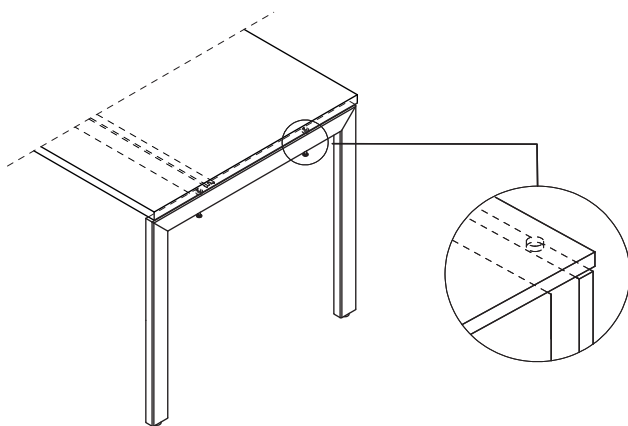

Attention - le chemin de câbles situé sous le plan de travail est uniquement disponible en : M009 - couleur aluminium semi-mat

## Bureaux manager sur meuble retour porteur

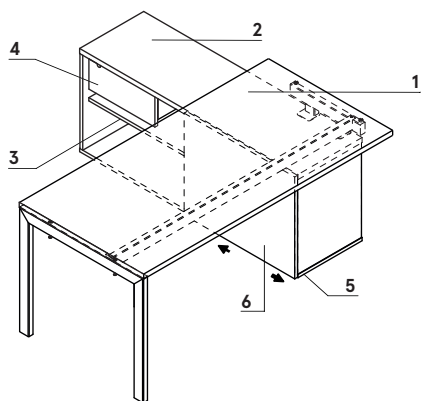

1. Plateau - mélaminé 28 mm, chants ABS
2. Top - mélaminé 28 mm, chants ABS
3. Tablette - mélaminé 18 mm, protection contre les chutes accidentelles, chants ABS
4. Tiroir - mélaminé 18 mm; chants ABS, serrure, possibilité de le changer de place
5. Base - mélaminé 18 mm, chants ABS
6. Façade - mélaminé 18 mm, chants ABS

## Exemples de configurations (mm)

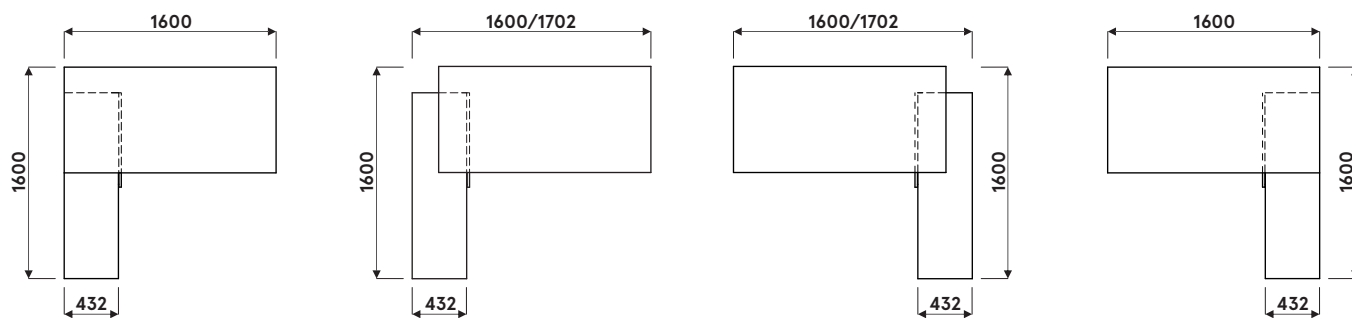

## Exemples de configurations (mm)

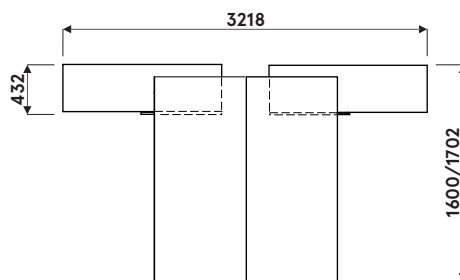
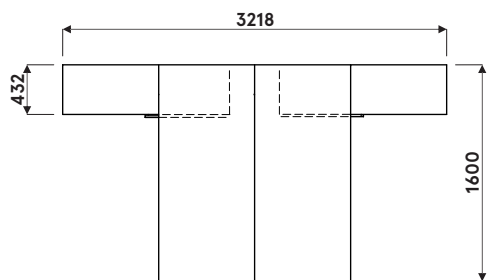

## Exemples de configuration avec BOX40, BOX50, BOX60

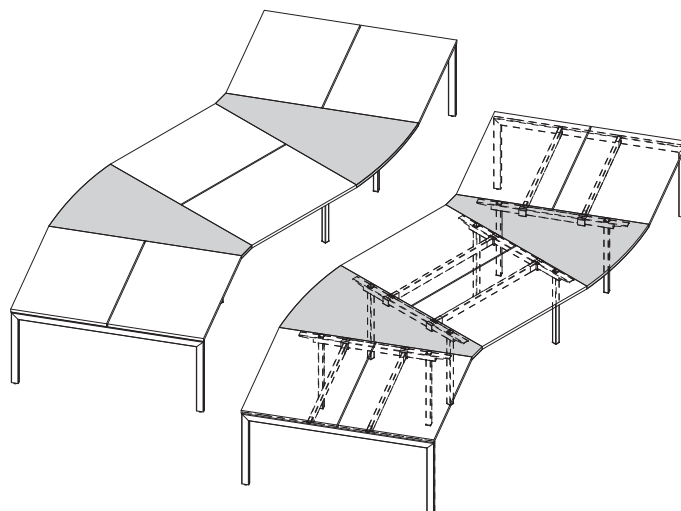
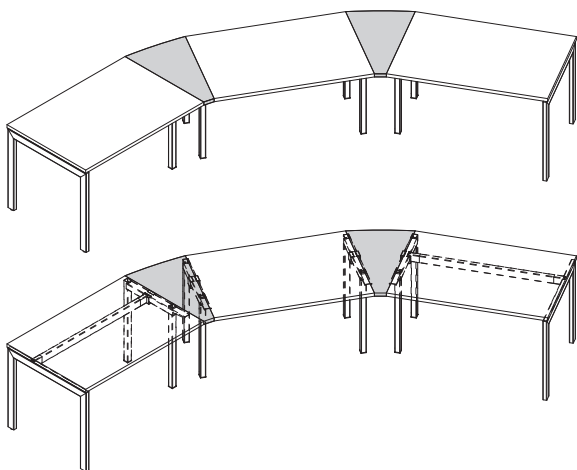

REMARQUE - Uniquement pour les systèmes Ogi Q, Ogi U, Ogi Y, Ogi M

## Accessoires

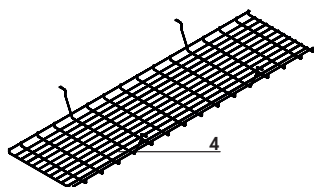
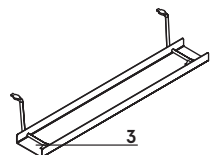
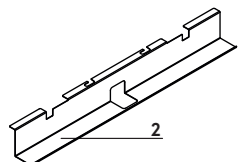
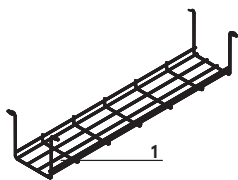

1. **Chemin de câbles S69** - métal finition peinture poudre époxy, couleur 09 - aluminium
2. **Chemin de câbles (SG12, SG16)** - pour bureau individuel, métal finition peinture poudre époxy, couleur M009 - aluminium semi-mate
3. **Chemin de câbles E64** - métal finition peinture poudre époxy, couleur M009 - aluminium semi-mate
4. **Chemin de câbles pour bench Ogi (SG220, SG260)** - fil acier Ø4 mm, métal finition peinture poudre époxy, couleur : 09 - aluminium

---

## Bureaux droits \*



**BOU12**  
1200 / 600 / 740  
29.7 kg

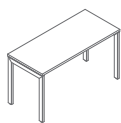

**BOU14**  
1400 / 600 / 740  
32.8 kg

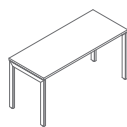

**BOU16**  
1600 / 600 / 740  
35.9 kg

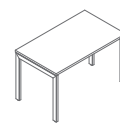

**BOU28**  
1200 / 700 / 740  
32.3 kg



**BOU29**  
1400 / 700 / 740  
35.7 kg

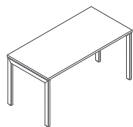

**BOU30**  
1600 / 700 / 740  
39.3 kg



**BOU19**  
1200 / 800 / 740  
37.8 kg



**BOU20**  
1400 / 800 / 740  
38.3 kg

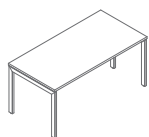

**BOU21**  
1600 / 800 / 740  
38.9 kg

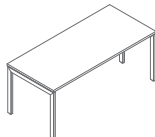

**BOU22**  
1800 / 800 / 740  
42 kg

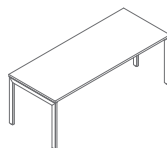

**BOU27**  
2000 / 800 / 740  
49.7 kg

---

## Élément suivant - pour bureau droit \*



**BOX40**  
500 / 800 / 740  
10.8 kg

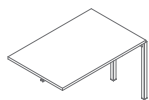

**BOX42**  
1200 / 800 / 740  
31.6 kg

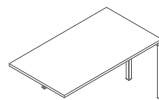

**BOX43**  
1400 / 800 / 740  
32.1 kg

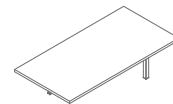

**BOX44**  
1600 / 800 / 740  
32.7 kg

---

---

## Élément suivant - pour bureau droit \*

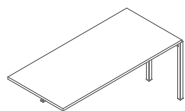

**BOX45**  
1600 / 800 / 740  
35.8 kg

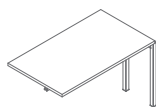

**BOX32**  
1200 / 700 / 740  
26.3 kg

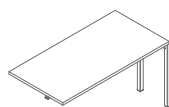

**BOX34**  
1400 / 700 / 740  
29.7 kg

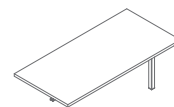

**BOX36**  
1600 / 700 / 740  
33.3 kg

---

## Bureaux compacts \*

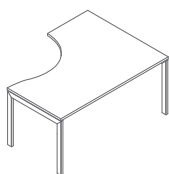

**BOU23**  
1600 / 1200 / 740  
46.1 kg

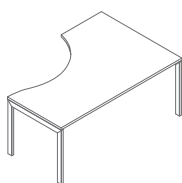

**BOU25**  
1800 / 1200 / 740  
42 kg

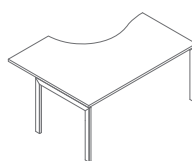

**BOU24**  
1600 / 1200 / 740  
46.1 kg

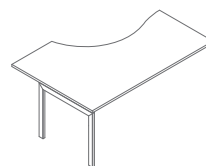

**BOU26**  
1800 / 1200 / 740  
44 kg

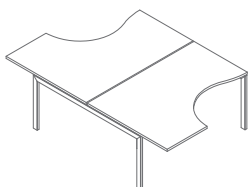

**BOU15**  
1600 / 2410 / 740  
85.5 kg

---

## Bureaux sur meuble retour porteur \*

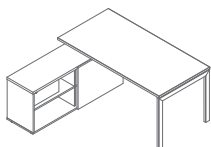

**BOUL20**  
1600-1702 / 1600 / 740  
92.9 kg

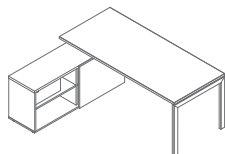

**BOUL21**  
1800-1902 / 1600 / 740  
96 kg

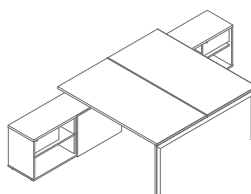

**BOUL40**  
1600-1702 / 3210 / 740  
182.6 kg

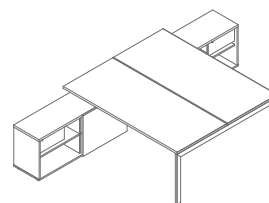

**BOUL41**  
1800-1902 / 3210 / 740  
188.8 kg

---

---

## Benchs \*

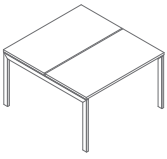

**BOU42**  
1200 / 1410 / 740  
57.1 kg

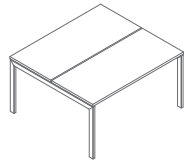

**BOU44**  
1400 / 1410 / 740  
63.9 kg

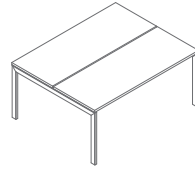

**BOU46**  
1600 / 1410 / 740  
71.1 kg

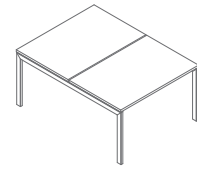

**BOU32**  
1200 / 1610 / 740  
68.9 kg

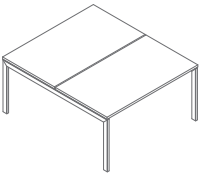

**BOU33**  
1400 / 1610 / 740  
69.9 kg

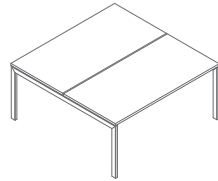

**BOU34**  
1600 / 1610 / 740  
71.1 kg

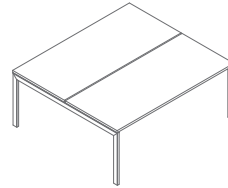

**BOU35**  
1800 / 1610 / 740  
77.3 kg

---

## Élément de jonction et élément suivant - pour bench \*

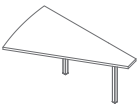

**BOX50**  
1000 / 1410 / 740  
16.5 kg

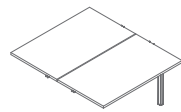

**BOX52**  
1200 / 1410 / 740  
49.4 kg

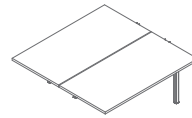

**BOX54**  
1400 / 1410 / 740  
56.2 kg

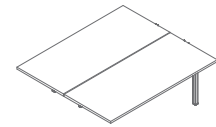

**BOX56**  
1600 / 1410 / 740  
63.4 kg

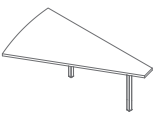

**BOX60**  
1000 / 1610 / 740  
17.5 kg

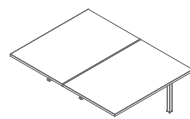

**BOX62**  
1200 / 1610 / 740  
60.1 kg

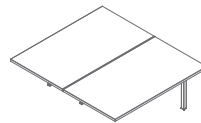

**BOX64**  
1400 / 1610 / 740  
61.1 kg

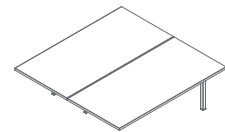

**BOX66**  
1600 / 1610 / 740  
62.3 kg

---



---

## Élément de jonction et élément suivant - pour bench \*

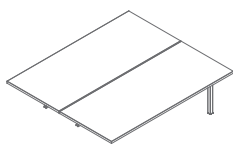

**BOX68**  
1800 / 1610 / 740  
68,5 kg

---

## Retours / extensions \*

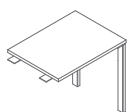

**PLU01**  
600 / 800 / 740  
18,4 kg

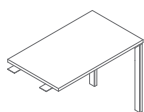

**PLU02**  
600 / 1000 / 740  
19,6 kg

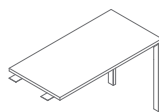

**PLU03**  
600 / 1200 / 740  
22,1 kg

---

---

## Plateau, top, base, corps, façade



14 Hêtre \*

26 Aluminium  
satiné

31 Chêne  
canadien \*

39 Bouleau clair \*



67 Blanc pastel

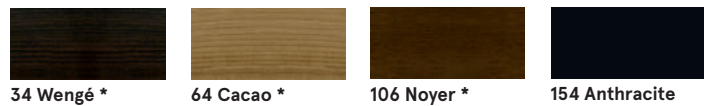

34 Wengé \*

64 Cacao \*

106 Noyer \*

154 Anthracite



08 Noir

167 Chêne gris

168 Chêne naturel

## Passes câbles

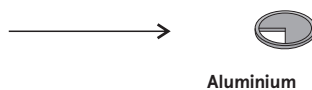

Aluminium

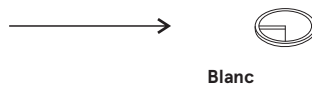

Blanc

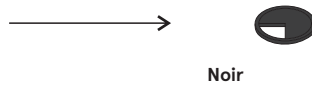

Noir

---

## Piètement, mediabox - métal

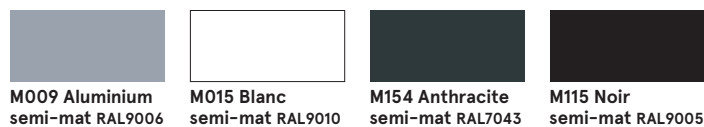

M009 Aluminium  
semi-mat RAL9006

M015 Blanc  
semi-mat RAL9010

M154 Anthracite  
semi-mat RAL7043

M115 Noir  
semi-mat RAL9005

---

\* corps - groupe II